

Small hole drilling



Small hole drilling

| | Page |
|--|------|
| H19 (3/4) Integral drill steels | 5 |
| H22 (7/8") Integral drill steels | 6 |
| Reaming tools | 7 |
| H22 Tapered tools, 12° taper | 8 |
| H22 Tapered tools, 11° taper..... | 9 |
| Stone working tools | 10 |
| R22 (7/8") Extension drilling tools | 11 |
| R23 (29/32") Extension drilling tools | 12 |
| R25 (1") Extension drilling tools | 13 |
| Sandvik Alpha. α 250 bit thread | 15 |
| R28 (1 1/8") Extension drilling tools | 16 |

Small hole drilling

H19 (3/4) Integral drill steels

| Series | Dimensions L | | | D | | Part No. |
|----------------------------------|-----------------|----|-----|----|---------|----------|
| | mm | ft | in | mm | in | |
| Shank 19 x 108 mm (3/4"x 4 1/4") | | | | | | |
| 21 | 400 | 1' | 4" | 29 | 19/64" | 724-0429 |
| | 800 | 2' | 7" | 28 | 1 7/64" | 724-0828 |
| | 1600 | 5' | 3" | 27 | 1 1/16" | 724-1627 |
| | 2400 | 7' | 10" | 26 | 1 1/32" | 724-2426 |
| 24 | 600 | 2' | - | 27 | 1 1/16" | 724-0627 |
| | 1200 | 3' | 11" | 26 | 1 1/32" | 724-1226 |
| Boulder steel | | | | | | |
| | 400 | 1' | 4" | 24 | 15/16" | 724-0424 |
| | 800 | 2' | 7" | 23 | 29/32" | 724-0823 |

Shank 22 x 108 mm (7/8"x 4 1/4")

| | | | | | | |
|----|------|----|----|----|---------|----------|
| 21 | 400 | 1' | 4" | 24 | 15/16" | 728-0424 |
| | 400 | 1' | 4" | 29 | 1 9/64" | 728-0429 |
| | 800 | 2' | 7" | 28 | 1 7/64" | 728-0828 |
| | 1600 | 5' | 3" | 27 | 1 1/16" | 728-1627 |

Small hole drilling

H22 (7/8") Integral drill steels

| Series | Dimensions L | | | D | | Part No. |
|---------------------------------|--------------|-----|-----|--------|-------------|-------------|
| | mm | ft | in | mm | in | |
| Shank 22x108 mm (7/8" x 4 1/4") | | | | | | |
| 11 | 800 | 2' | 7" | 34 | 1 11/32" | 714-0834-65 |
| | 1600 | 5' | 3" | 33 | 1 19/64" | 714-1633-65 |
| | 2400 | 7' | 10" | 32 | 1 1/4" | 714-2432-65 |
| | 3200 | 10' | 6" | 31 | 1 7/32" | 714-3231 |
| | 4000 | 13' | 1" | 30 | 1 3/16" | 714-4030 |
| | 4800 | 15' | 9" | 29 | 1 9/64" | 714-4829 |
| | 5600 | 18' | 4" | 28 | 1 7/64" | 714-5628-50 |
| | 6400 | 21' | - | 27 | 1 1/16" | 714-6427-50 |
| | 7200 | 23' | 8" | 26 | 1 1/32" | 714-7226-50 |
| | 12 | 800 | 2' | 7" | 40 | 1 37/64" |
| 1600 | | 5' | 3" | 39 | 1 17/32" | 714-1639-65 |
| 2400 | | 7' | 10" | 38 | 1 1/2" | 714-2438-65 |
| 3200 | | 10' | 6" | 37 | 1 29/64" | 714-3237-65 |
| 4000 | | 13' | 1" | 36 | 1 27/64" | 714-4036-65 |
| 4800 | | 15' | 9" | 35 | 1 3/8" | 714-4835-65 |
| 5600 | | 18' | 4" | 34 | 1 11/32" | 714-5634-65 |
| 6400 | | 21' | - | 33 | 1 19/64" | 714-6433-65 |
| 7200 | 23' | 8" | 32 | 1 1/4" | 714-7232-65 | |
| 13 | 400 | 1' | 4" | 34 | 1 11/32" | 714-0434-65 |
| | 800 | 2' | 7" | 33 | 1 19/64" | 714-0833-65 |
| | 1200 | 3' | 11" | 32 | 1 1/4" | 714-1232-65 |
| | 1600 | 5' | 3" | 31 | 1 7/32" | 714-1631 |
| | 2000 | 6' | 7" | 30 | 1 3/16" | 714-2030 |
| 16 | 600 | 2' | - | 35 | 1 3/8" | 714-0635-65 |
| | 1200 | 3' | 11" | 34 | 1 11/32" | 714-1234-65 |
| | 1800 | 5' | 11" | 33 | 1 19/64" | 714-1833-65 |
| | 2400 | 7' | 10" | 32 | 1 1/4" | 714-2432-65 |
| 17 | 600 | 2' | - | 41 | 1 5/8" | 714-0641-65 |
| | 1200 | 3' | 11" | 40 | 1 37/64" | 714-1240-65 |
| | 1800 | 5' | 11" | 39 | 1 17/32" | 714-1839-65 |
| | 2400 | 7' | 10" | 38 | 1 1/2" | 714-2438-65 |

Shank 22x108 mm (7/8" x 4 1/4")

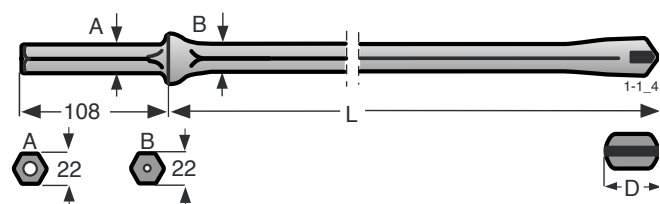

| | | | | | |
|------|-----|-----|----|----------|---------------|
| 2000 | 6' | 7" | 33 | 1 19/64" | 714-2033-65 |
| 8000 | 26' | 3" | 26 | 1 1/32" | 714-8026-50 |
| 8800 | 28' | 11" | 25 | 1" | 714-8825-5005 |
| 9600 | 31' | 6" | 25 | 1" | 714-9625-5005 |

Shank 22x108 mm (7/8" x 4 1/4")

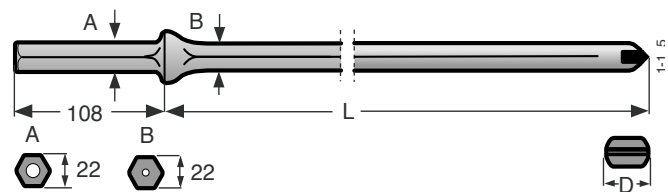

| | | | | | |
|------|----|-----|----|---------|-------------|
| 800 | 2' | 7" | 29 | 1 9/64" | 714-0829 |
| 1600 | 5' | 3" | 28 | 1 7/64" | 714-1628-50 |
| 2400 | 7' | 10" | 27 | 1 1/16" | 714-2427-50 |

Small hole drilling

Reaming tools



| | L | | | D | | Part No. |
|-----------------------------|------|----|---------|----|---------|--------------|
| | mm | ft | in | mm | in | |
| Pilot rod, Hex 22, 6° taper | | | | | | |
| | 800 | 2' | 7 1/2" | 26 | 1 1/32" | 7922-6108-11 |
| | 1200 | 3' | 11 3/4" | 26 | 1 1/32" | 7922-6112-11 |
| | 1600 | 5' | 3" | 26 | 1 1/32" | 7922-6116-11 |
| | 2000 | 6' | 6 3/4" | 26 | 1 1/32" | 7922-6120-11 |
| | 2500 | 8' | 2 1/2" | 26 | 1 1/32" | 7922-6124-11 |

| | Buttons, mm | | Angle | Dimensions D | | Part No. |
|-----------------------|---------------|---------------|-------|--------------|--------|---------------|
| | Front No Size | Gauge No Size | | mm | in | |
| Reaming bit, 6° taper | | | | | | |
| | 4x8 | 8x9 | 25° | 64 | 2 1/2" | 7722-4864-S45 |
| | 4x10 | 8x10 | 30° | 76 | 3" | 7722-4876-S45 |
| | 4x10 | 8x10 | 30° | 89 | 3 1/2" | 7722-4889-S45 |

Knock-off tool for reaming bit

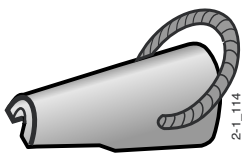

795-1469

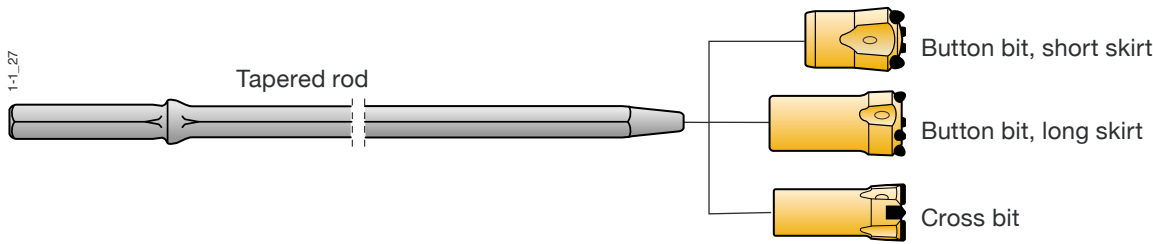

Small hole drilling

H22 Tapered tools, 12° taper

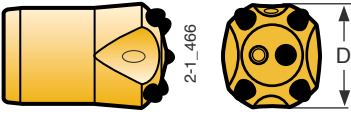
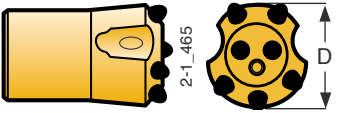

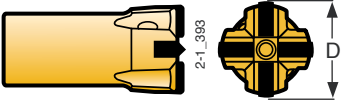
| | Flushinghole, mm | | Buttons, mm | | | Dimensions | | Part No. |
|--|------------------|---------------|-------------|---------------|-------|------------|---------|---------------|
| | Front No | Gauge No Size | Front No | Gauge No Size | Angle | D mm | in | |
| Button bit | | | | | | | | |
|  | 1x5 | 1x5 | 1x7 | 4x7 | 35° | 28 | 1 1/8" | 7795-6428-B48 |
| | 1x5 | 1x5 | 1x7 | 4x7 | 35° | 30 | 1 3/16" | 7795-6430-B48 |
| Button bit | | | | | | | | |
|  | 2x4 | 1x4 | 2x7 | 5x7 | 40° | 32 | 1 1/4" | 7795-5232-B48 |
| | 2x4 | 1x3,5 | 2x7 | 5x8 | 40° | 35 | 1 3/8" | 7795-5235-B48 |
| | 2x4 | 1x4 | 2x7 | 5x9 | 40° | 38 | 1 1/2" | 7795-5238-B48 |
| Button bit | | | | | | | | |
|  | 2x4 | 1x3.5 | 2x7 | 5x7 | 40° | 33 | 1 9/64" | 7770-5233-B48 |
| | 2x4 | 1x3.5 | 2x7 | 5x8 | 40° | 35 | 1 3/8" | 7770-5235-B48 |
| Cross bit | | | | | | | | |
|  | 1x4 | 2x4 | - | - | - | 28 | 1 1/8" | 7770-9028-42 |
| | 1x4 | 2x4 | - | - | - | 30 | 1 3/16" | 7770-9030-42 |
| | 1x6 | 2x4.5 | - | - | - | 32 | 1 1/4" | 7770-9032-42 |
| | 1x6 | 2x4.5 | - | - | - | 35 | 1 3/8" | 7770-9035-42 |

| | Dimensions | | D | | Part No. | |
|--|------------|-------|----|----|----------|--------------|
| | L mm | ft in | mm | in | | |
| Tapered rod, shank 22x108, carburized | | | | | | |
|  | 610 | 2' | - | 22 | 7/8" | 7870-6106-11 |
| | 1220 | 4' | - | 22 | 7/8" | 7870-6112-11 |
| | 1830 | 6' | - | 22 | 7/8" | 7870-6118-11 |
| | 2000 | 6' | 7" | 22 | 7/8" | 7870-6120-11 |
| | 2440 | 8' | - | 22 | 7/8" | 7870-6124-11 |
| | 3050 | 10' | - | 22 | 7/8" | 7870-6131-11 |
| | 3660 | 12' | - | 22 | 7/8" | 7870-6137-11 |

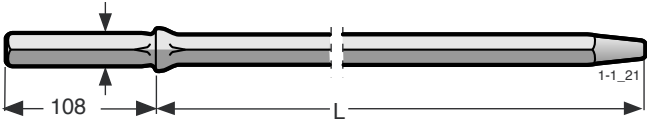
| | Dimensions | | D | | Part No. | |
|--|------------|-------|---------|----|----------|--------------|
| | L mm | ft in | mm | in | | |
| Tapered rod, shank 22x108, HF-hardened - For surface drilling | | | | | | |
|  | 2440 | 8' | - | 22 | 7/8" | 7870-5124-11 |
| | 3200 | 10' | 6" | 22 | 7/8" | 7870-5132-11 |
| | 4000 | 13' | 1 1/2" | 22 | 7/8" | 7870-1140-11 |
| | 4400 | 14' | 5" | 22 | 7/8" | 7870-1144-11 |
| | 4800 | 15' | 9" | 22 | 7/8" | 7870-1148-11 |
| | 5600 | 18' | 4 1/2" | 22 | 7/8" | 7870-1156-11 |
| | 6400 | 21' | - | 22 | 7/8" | 7870-1164-11 |
| | 7200 | 23' | 7 1/2" | 22 | 7/8" | 7870-1172-11 |
| | 8000 | 26' | 3" | 22 | 7/8" | 7870-1180-11 |
| | 8800 | 28' | 10 1/2" | 22 | 7/8" | 7870-1188-11 |

Small hole drilling

H22 Tapered tools, 11° taper

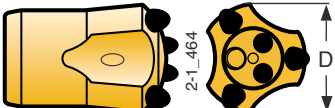

| | Flushinghole, mm | | Buttons, mm | | Angle | Dimensions | | Part No. |
|---|------------------|---------|-------------|---------|-------|------------|----------|---------------|
| | Front | Gauge | Front | Gauge | | D | in | |
| Button bit | No Size | No Size | No Size | No Size | | mm | | |
|  | 1x6 | 2x4 | 2x7 | 3x8 | 35° | 32 | 1 1/4" | 7776-1932-B48 |
| | 1x6 | 1x6 | 1x8 | 3x9 | 40° | 36 | 1 7/16" | 7776-1936-B48 |
| | 1x6 | 1x6 | 2x8 | 3x9 | 40° | 38 | 1 1/2" | 7776-1938-B48 |
| | 1x6 | 1x6 | 2x8 | 3x9 | 40° | 40 | 1 37/64" | 7776-1940-B48 |

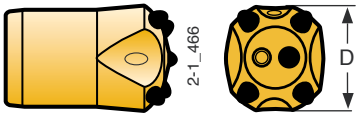
| | | | | | | | | |
|--|-----|-----|-----|-----|-----|----|--------|---------------|
| Button bit | | | | | | | | |
|  | 1x6 | 1x6 | 2x8 | 4x8 | 40° | 38 | 1 1/2" | 7776-6438-B48 |

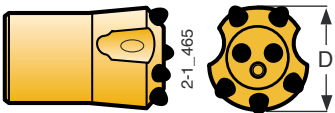
| | | | | | | | | |
|---|-----|-----|-----|-----|-----|----|----------|---------------|
| Button bit | | | | | | | | |
|  | 1x4 | 1x6 | 2x7 | 5x7 | 40° | 32 | 1 1/4" | 7776-4432-B48 |
| | 1x5 | 1x5 | 2x7 | 5x7 | 35° | 35 | 1 3/8" | 7776-4435-B48 |
| | 1x6 | 1x5 | 2x7 | 5x8 | 35° | 38 | 1 1/2" | 7776-4438-B48 |
| | 1x6 | 1x5 | 2x8 | 5x9 | 35° | 40 | 1 37/64" | 7776-4440-B48 |

| | Dimensions | | | D | | Part No. |
|---|------------|-----|--------|----|------|--------------|
| | L | ft | in | mm | in | |
| Tapered rod, shank 22x108, carburized | | | | | | |
|  | 610 | 2' | - | 22 | 7/8" | 7876-6106-11 |
| | 800 | 2' | 7 1/2" | 22 | 7/8" | 7876-6108-11 |
| | 1220 | 4' | - | 22 | 7/8" | 7876-6112-11 |
| | 1830 | 6' | - | 22 | 7/8" | 7876-6118-11 |
| | 2000 | 6' | 7" | 22 | 7/8" | 7876-6120-11 |
| | 2440 | 8' | - | 22 | 7/8" | 7876-6124-11 |
| | 3050 | 10' | - | 22 | 7/8" | 7876-6131-11 |
| | 3600 | 11' | 9 1/2" | 22 | 7/8" | 7876-6136-11 |

Small hole drilling

Stone working tools

Plug hole integral steel

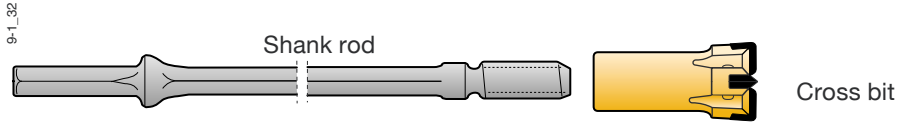

| | Dimensions | | | D | | Part No. |
|--------------------------|------------|----|----------|----|--------|----------|
| | L | ft | in | mm | in | |
| Plug hole integral steel | | | | | | |
| | 150 | | 6" | 17 | 21/32" | 721-1517 |
| | 160 | | 6 1/4" | 20 | 25/32" | 721-1620 |
| | 200 | | 7 7/8" | 20 | 25/32" | 721-2020 |
| | 240 | | 9 29/64" | 20 | 25/32" | 721-2420 |
| | 280 | | 11 1/32" | 20 | 25/32" | 721-2820 |
| | 310 | | 11 1/4" | 20 | 25/32" | 721-3120 |
| | 160 | | 6 1/4" | 22 | 7/8" | 721-1622 |
| | 190 | | 7 1/2" | 22 | 7/8" | 721-1922 |

Shank rod, Hex22 - R25

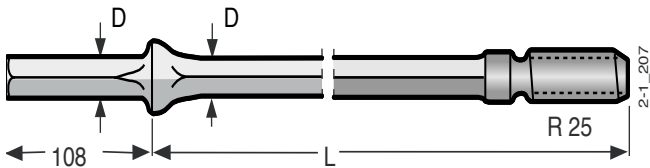

| | | | | | | |
|--|------|----|----------|----|------|--------------|
| | 255 | | 10 3/64" | 22 | 7/8" | 7802-6103-13 |
| | 800 | 2' | 2 1/2" | 22 | 7/8" | 7802-6108-13 |
| | 1000 | 3' | 3" | 22 | 7/8" | 7802-6110-13 |

Cross bit, R25

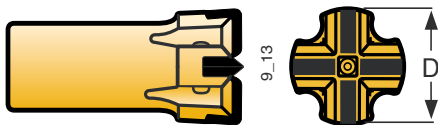

| | | |
|--|----------|--------------|
| | 381 1/2" | 7732-1438-42 |
| | 411 5/8" | 7732-1441-42 |
| | 451 3/4" | 7732-1045-42 |

Small hole drilling

R22 (7/8") Extension drilling tools

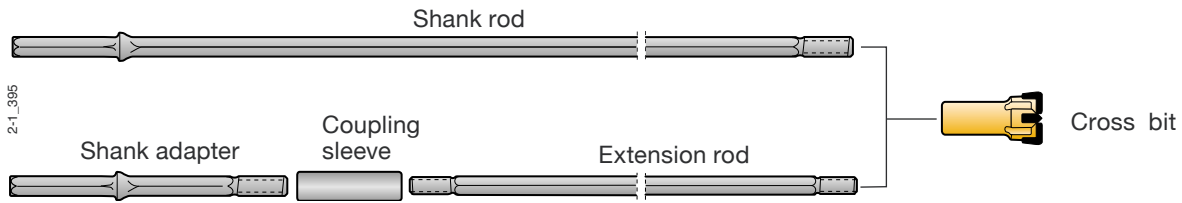

| | Flushing hole, mm | | D | | Bit classification | Part No. |
|--|-------------------|---------------|----|----|--------------------|----------|
| | Front No Size | Gauge No Size | mm | in | | |

Cross bit



| | | | | | | | |
|---|-----|---|-----|----|--------|---|--------------|
| 1 | 4.5 | 2 | 4.5 | 38 | 1 1/2" | - | 7731-1038-42 |
|---|-----|---|-----|----|--------|---|--------------|

Dimensions

| L | Dimensions | | | D | | Part No. |
|---|------------|----|----|----|----|----------|
| | mm | ft | in | mm | in | |

Extension rod R22 - Hex 22 - R22

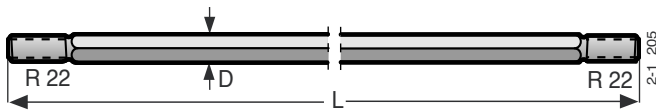

| | | | | | |
|------|----|-----|----|------|--------------|
| 800 | 2' | 7" | 22 | 7/8" | 7851-1308-20 |
| 1200 | 3' | 11" | 22 | 7/8" | 7851-1312-20 |
| 1600 | 5' | 3" | 22 | 7/8" | 7851-1316-20 |

Coupling sleeve, R22

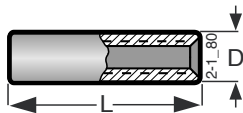

| | | | | | |
|-----|---|--------|----|---------|-----------|
| 140 | - | 5 1/2" | 31 | 1 7/32" | 7991-2031 |
|-----|---|--------|----|---------|-----------|

Shank adapter/Shank rod, Hex 22 - R22

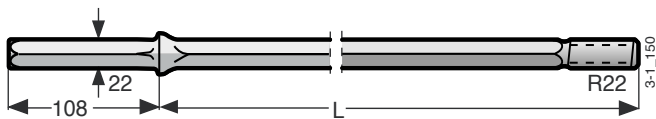

| | | | | | |
|------|----|----------|----|------|--------------|
| 255 | - | 10 3/64" | 22 | 7/8" | 7801-6103-13 |
| 1000 | 3' | 3" | 22 | 7/8" | 7801-6110-13 |

Small hole drilling

R23 (29/32") Extension drilling tools

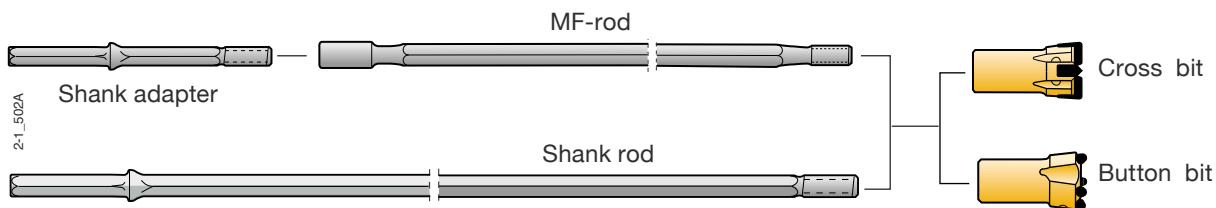

| | Flushinghole, mm | | Buttons, mm | | Angle | Dimensions | | Bit classification | Part No. |
|--|------------------|------------|-------------|------------|-------|------------|----|--------------------|----------|
| | Front No | Gauge Size | Front No | Gauge Size | | D mm | in | | |

Button bit

| | | | | | | | | | | | |
|--|---|-----|---|---|-----|-----|-----|----|--------|------|----------------|
| | 1 | 5.0 | 1 | 6 | 2x7 | 5x8 | 40° | 35 | 1 3/8" | HMCA | 7737-5235-R48 |
| | 1 | 6.0 | 1 | 6 | 2x7 | 5x8 | 35° | 38 | 1 1/2" | HMCA | 7737-4438A-B48 |
| | 1 | 5.0 | 1 | 6 | 2x8 | 5x9 | 35° | 41 | 1 5/8" | HMCA | 7737-5241-R48 |
| | 3 | 5.0 | - | - | 3x8 | 6x9 | 30° | 45 | 1 3/4" | HMCA | 7737-5345-R48 |

Cross bit, Extra Heavy Duty

| | | | | | | | | | | | |
|--|---|-----|---|-----|---|---|---|----|---------|---|--------------|
| | 1 | 4.5 | 2 | 4.5 | - | - | - | 33 | 1 5/16" | - | 7737-1633-11 |
|--|---|-----|---|-----|---|---|---|----|---------|---|--------------|

Cross bit, Heavy Duty

| | | | | | | | | | | | |
|--|---|-----|---|-----|---|---|---|----|--------|---|--------------|
| | 1 | 4.5 | 2 | 4.5 | - | - | - | 35 | 1 3/8" | - | 7737-1435-42 |
| | 1 | 4.5 | 2 | 4.5 | - | - | - | 38 | 1 1/2" | - | 7737-1438-42 |

MF-rod, R23 - Hex 22 - R23

| | | | | | | |
|--|------|-----|---------|----|------|--------------|
| | 2095 | 6' | 10 1/2" | 22 | 7/8" | 7857-4821-20 |
| | 3050 | 10' | - | 22 | 7/8" | 7857-4831-20 |

Female end OD 31 mm.

Shank adapter / Shank rod, Hex 22 - R23

| | | | | | | |
|--|------|-----|----------|----|------|--------------|
| | 255 | - | 10 3/64" | 22 | 7/8" | 7807-6103-11 |
| | 2400 | 8' | - | 22 | 7/8" | 7807-6124-11 |
| | 3200 | 10' | - | 22 | 7/8" | 7807-6132-11 |
| | 3600 | 11' | 9 5/8" | 22 | 7/8" | 7807-6136-11 |







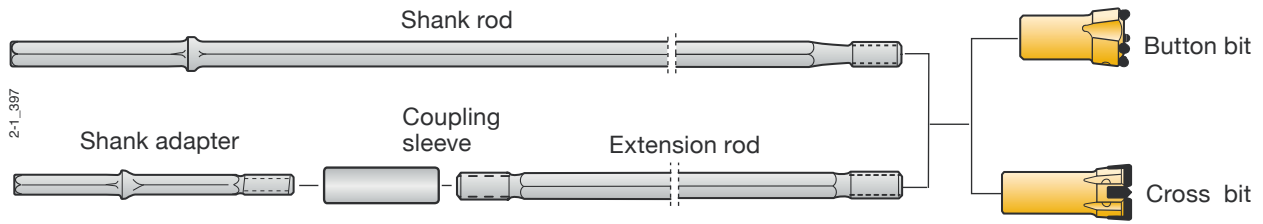

Shank rod, Hex 25 - R23

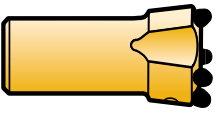
| | | | | | | |
|--|------|-----|----------|----|----|--------------|
| | 255 | - | 10 3/64" | 25 | 1" | 7807-7103-11 |
| | 3600 | 11' | 9" | 25 | 1" | 7807-7136-11 |

Small hole drilling

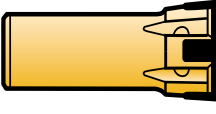
R25 (1") Extension drilling tools

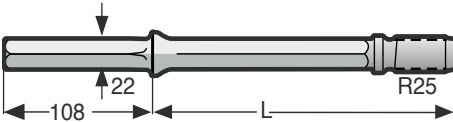

| | Flushinghole, mm | | Buttons, mm | | | Dimensions | | Bit classification | Part No. | |
|---|------------------|------------|-------------|------------|-------|------------|----|--------------------|----------|----------------|
| | Front No | Gauge Size | Front No | Gauge Size | Angle | D mm | in | | | |
| Button bit | | | | | | | | | | |
|   | 1) | 1x5 | 1x6 | 2x7 | 5x8 | 35° | 35 | 1 3/8" | HMCA | 7732-5235-S48 |
| | 1) | 1x5 | 1x6 | 2x7 | 5x9 | 30° | 38 | 1 1/2" | HMCA | 7732-5238-S48 |
| | | 1x5 | 1x6 | 2x7 | 5x9 | 35° | 38 | 1 1/2" | HMCA | 7732-5238-R48 |
| | | 1x5 | 1x6 | 2x8 | 5x9 | 35° | 41 | 1 5/8" | HMCA | 7732-5241-S48 |
|   | | 3x4.5 | - | 3x8 | 6x9 | 40° | 45 | 1 3/4" | MSCFAN | 7732-5345F-R48 |
| Cross bit, Heavy Duty | | | | | | | | | | |
|   | 1) | 1x5 | 2x5 | - | - | - | 35 | 1 3/8" | - | 7732-1435-42 |
| | 1) | 1x5 | 2x5 | - | - | - | 38 | 1 1/2" | - | 7732-1438-42 |
| | | 1x5 | 2x5 | - | - | - | 41 | 1 5/8" | - | 7732-1441-42 |
| Cross bit | | | | | | | | | | |
|   | | 1x5 | 2x5 | - | - | - | 45 | 1 3/4" | - | 7732-1045-42 |
| | | 1x5 | 2x5 | - | - | - | 51 | 2" | - | 7732-1051-42 |

| Shank adapter / rod, Hex 22 x R25 | Dimensions | | Dimensions | | Part No. |
|---|------------|----|------------|---------|--------------|
| | L mm | ft | in | D mm in | |
|  | 255 | - | 10 3/64" | 22 7/8" | 7802-6103-13 |
| | 800 | 2' | 7" | 22 7/8" | 7802-6108-13 |
| | 1000 | 3' | 3" | 22 7/8" | 7802-6110-13 |

1) For one-rod drilling.

Small hole drilling

R25 (1") Extension drilling tools

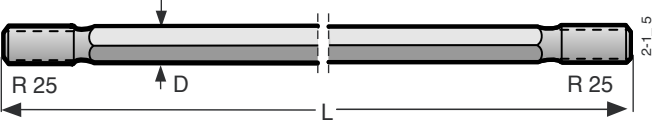
| | Dimensions | | | D | | Part No. |
|--|------------|-----|----|----|----|--------------|
| | L | | | mm | in | |
| | mm | ft | in | | | |
| Extension rod, R25 - Hex 25 - R25 | | | | | | |
|  | 915 | 3' | - | 25 | 1" | 7852-2309-20 |
| | 1220 | 4' | - | 25 | 1" | 7852-2312-20 |
| | 1525 | 5' | - | 25 | 1" | 7852-2315-20 |
| | 1830 | 6' | - | 25 | 1" | 7852-2318-20 |
| | 2435 | 8' | - | 25 | 1" | 7852-2324-20 |
| | 3050 | 10' | - | 25 | 1" | 7852-2331-20 |

Coupling sleeve, R25

| | | | | | | |
|--|-----|---|--------|----|--------|-----------|
|  | 160 | - | 6 1/4" | 35 | 1 3/8" | 7992-2035 |
|--|-----|---|--------|----|--------|-----------|

Small hole drilling

Sandvik Alpha. α 250 bit thread



Shank rod

Button bit

| Flushinghole, mm | | Buttons, mm | | Dimensions D | Bit classi- fication | Part No. |
|------------------|---------|-------------|---------|-----------------|----------------------------|----------|
| Front | Gauge | Front | Gauge | | | |
| No Size | No Size | No Size | No Size | Angle | | |

Button bit



| | | | | | | | | |
|-----|-----|-----|-----|-----|----|--------|------|---------------|
| 1x5 | 1x6 | 2x7 | 5x8 | 40° | 35 | 1 3/8" | HMCA | 7764-5235-R48 |
| 1x5 | 1x6 | 2x7 | 5x9 | 35° | 38 | 1 1/2" | HMCA | 7764-5238-R48 |

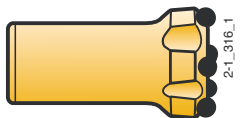

| | | | | | | | | |
|-------|---|-----|-----|-----|----|--------|--------|----------------|
| 3x4.5 | - | 3x8 | 6x9 | 40° | 45 | 1 3/4" | MSCFAN | 7764-5345F-R48 |
|-------|---|-----|-----|-----|----|--------|--------|----------------|

Dimensions

| L | | | D | | Part No. |
|----|----|----|----|----|----------|
| mm | ft | in | mm | in | |

Shank rod, Hex 25 - α 250

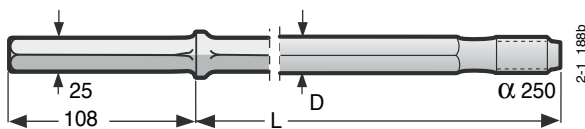

| | | | | | |
|------|-----|---------|----|----|--------------|
| 3600 | 11' | 9 5/8 " | 25 | 1" | 7814-7136-11 |
|------|-----|---------|----|----|--------------|

Small hole drilling

R28 (1 1/8") Extension drilling tools

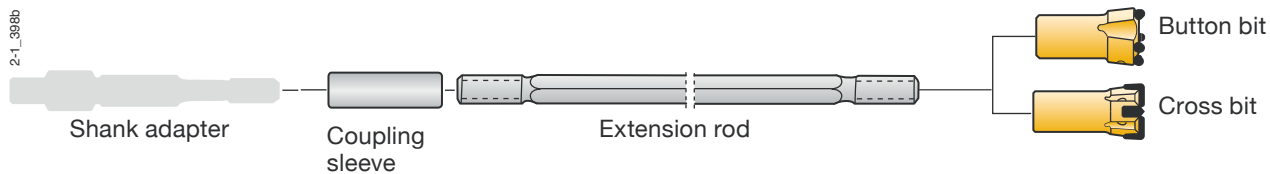

| | Flushinghole, mm | | Buttons, mm | | | Dimensions | | Bit classification | Part No. | |
|---------------------|------------------|------------|-------------|------------|-------|------------|----|--------------------|----------|---------------|
| | Front No | Gauge Size | Front No | Gauge Size | Angle | D mm | in | | | |
| Button bit, CAPP 52 | | | | | | | | | | |
| | 1) | 1x5 | 1x6 | 2x7 | 5x9 | 35° | 38 | 1 1/2" | MSCFAN | 7739-5238-R48 |
| | 1) | 1x5 | 1x6 | 2x7 | 5x9 | 30° | 38 | 1 1/2" | HMCA | 7739-5238-S48 |
| | 1) | 1x5 | 1x6 | 2x8 | 5x9 | 35° | 41 | 1 5/8" | HMCA | 7739-5241-S48 |
| | | 1x5 | 1x6 | 2x8 | 5x10 | 35° | 43 | 1 11/16" | HMCA | 7739-5243-S48 |

Cross bit, Heavy Duty

| | | | | | | | | | | |
|--|----|-----|-----|---|---|---|----|--------|---|--------------|
| | 1) | 1x5 | 2x5 | - | - | - | 38 | 1 1/2" | - | 7739-1438-42 |
| | 1) | 1x5 | 2x5 | - | - | - | 41 | 1 5/8" | - | 7739-1441-42 |

| | Dimensions | | Part No. | | |
|-----------------------------------|------------|-------|----------|-----------|--------------|
| | L mm | ft in | D mm | in | |
| Extension rod, R28 - Hex 28 - R28 | | | | | |
| | 3050 | 10' | - | 28 1 1/8" | 7859-2931-20 |

Coupling sleeve, R28

| | | | | | |
|--|-----|---|----------|-------------|-----------|
| | 150 | - | 5 29/32" | 40 1 37/64" | 7999-3640 |
|--|-----|---|----------|-------------|-----------|

1) For one-rod drilling.