



# Style 90 Compression Fittings For Water Service Applications

---

**For Joining Steel Pipe to Steel Pipe (Seal Only)**

**DRESSER Piping Specialties**

**DRESSER**



# Style 90 Fittings for Water Service

## For Joining Steel Pipe to Steel Pipe (Seal Only)

Over the years, millions of Dresser® Style 90 couplings and fittings have been installed on water service lines where they have helped to speed installation and cut costs.

Style 90 couplings and fittings consist of a cast iron or forged steel body; two resilient, specially compounded gaskets; two steel, self-centering protective gasket retainer cups; and two heavy end nuts. All fittings are shipped assembled, ready-to-use and install in just a few minutes.

### End Nut

- High grade iron, perfectly formed and rigidly inspected.
- Long threading affords reserve “take-up” on gasket when needed and prevents stripping.
- Clearance between pipe and nut permits more deflection of pipe (possible because gasket-retainer cup also confines gasket).
- Robust thread design resists stripping. (Test torques of 600 ft. lbs. reveal no stripping.)
- Coarse, rugged threads make for easy starting.

### Body

- Machined, wedge-shaped flare provides a perfect gasket seat and uniform pack at all points.
- Thickness always at least equal to that of pipe (on couplings, ells & tees).
- Made of rugged iron or steel.
- Longitudinal pipe movement up to 1/16” per gasket may be safely absorbed.

### Gasket Retainer Cup

- Cup-shaped design protects gasket.
- Prevents friction between the gasket and end nut, resulting in consistent high performance.
- Eliminates gasket interference in end nut threads, providing an accurate sense of tightness.
- Closely confines the gasket, permitting more clearance between the end nut and pipe, and greater pipe deflection.

### Gasket

- An ample, wedge-shaped section gives reserve packing power and high gasket pressure.
- Scientifically compounded rubber is made to last the life of the pipe.
- Interchangeable with most of the corresponding sizes of gaskets used in Style 38 bolted couplings.

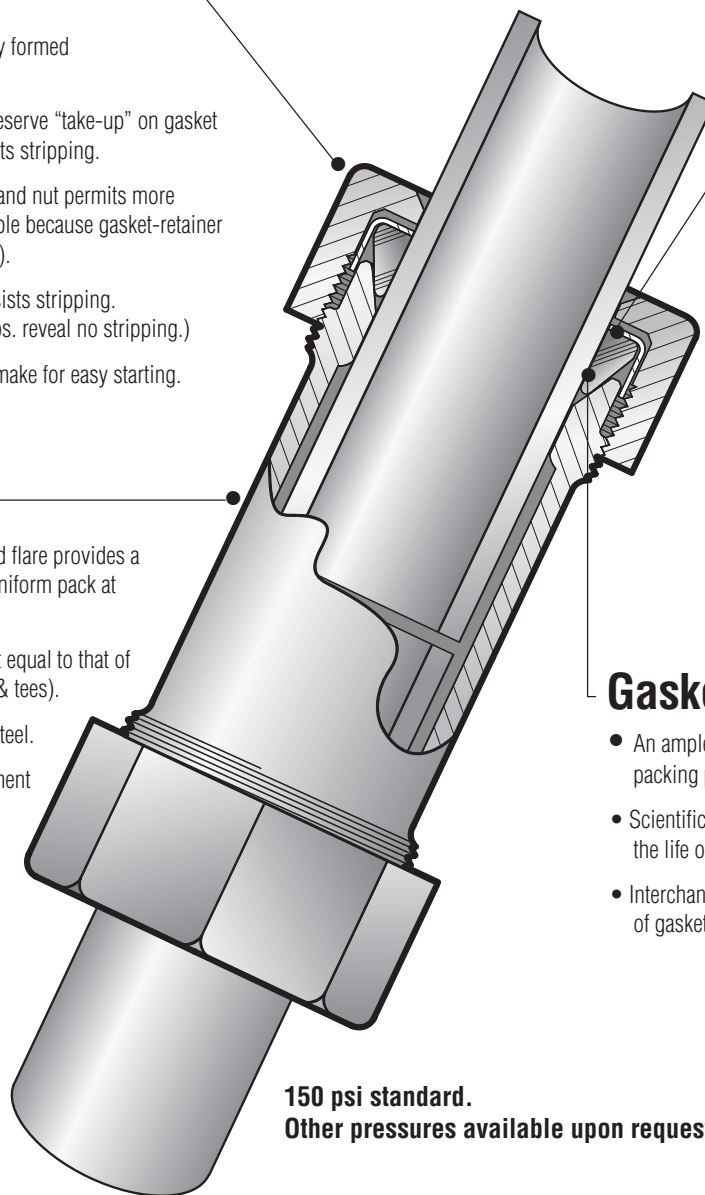

**150 psi standard.**  
**Other pressures available upon request.**

# Style 90 Fittings for Water Service

For Joining Steel Pipe (Seal Only)

Nominal Size (IPS) (In.)	Outside Diameter (O.D.) (In.)	E-Coat Part Number	Overall Dimensions					Dimension Drawings
			A	B	C	D	E	
<b>CAST COUPLING WITH 5" MIDDLE RING - SEAL ONLY</b>								
1/2	.840	0090-0014-082	2	5 7/8	5	--	--	
3/4	1.050	0090-0001-082	2 7/32	5 7/8	5	--	--	
1	1.315	0090-0002-082	2 9/16	5 7/8	5	--	--	
1 1/4	1.660	0090-0003-082	3	5 7/8	5	--	--	
1 1/2	1.900	0090-0004-082	3 3/8	5 5/16	5	--	--	
2	2.375	0090-0005-082	4	6 1/8	5	--	--	
<b>STEEL COUPLING WITH 5" MIDDLE RING - SEAL ONLY</b>								
3/4	1.050	0090-2101-082	2 7/32	5 7/8	5	--	--	
1	1.315	0090-2102-082	2 9/16	5 7/8	5	--	--	
1 1/4	1.660	0090-2103-082	3	5 7/8	5	--	--	
1 1/2	1.900	0090-2104-082	3 3/8	5 5/16	5	--	--	
2	2.375	0090-2105-082	4	6 1/8	5	--	--	
<b>STEEL COUPLING WITH 10" MIDDLE RING - SEAL ONLY</b>								
3/4	1.050	0090-0090-082	2 7/32	10 7/8	10	--	--	
1	1.315	0090-0091-082	2 9/16	10 7/8	10	--	--	
1 1/4	1.660	0090-0092-082	3	10 7/8	10	--	--	
1 1/2	1.900	0090-0093-082	3 3/8	10 7/8	10	--	--	
2	2.375	0090-0094-082	4	11 1/8	10	--	--	
<b>REDUCING COUPLING - SEAL ONLY</b>								
3/4 x 1/2	1.050 x .840	0090-0590-082	2 7/32	5 7/8	5	2	--	
1 x 3/4	1.315 x 1.050	0090-0580-082	2 9/16	5 7/8	5	2 7/32	--	
1 1/4 x 3/4	1.660 x 1.050	0090-0581-082	3	5 7/8	5	2 7/32	--	
1 1/4 x 1	1.660 x 1.315	0090-0582-082	3	5 7/8	5	2 9/16	--	
1 1/2 x 3/4	1.900 x 1.050	0090-0583-082	3 3/8	5 7/8	5	2 7/32	--	
1 1/2 x 1	1.900 x 1.315	0090-0584-082		5 7/8	5		--	
1 1/2 x 1 1/4	1.900 x 1.660	0090-0585-082	3 3/8	5 7/8	5	3	--	
2 x 3/4	2.375 x 1.050	0090-0586-082	4	6	5	2 7/32	--	
2 x 1	2.375 x 1.315	0090-0587-082	4	6	5		--	
2 x 1 1/4	2.375 x 1.660	0090-0588-082	4	6	5	3	--	
2 x 1 1/2	2.375 x 1.900	0090-0591-082	4	6	5	3 3/8	--	
<b>REGULAR TEE - SEAL ONLY</b>								
3/4 x 3/4 x 3/4	1.050 x 1.050 x 1.050	0090-0710-082	2 7/32	6 1/4	5 3/8	1 1/16	3 1/8	
1 x 1 x 1	1.315 x 1.315 x 1.315	0090-0711-082	2 9/16	5 7/8	5	1 1/16	3 7/16	
1 1/4 x 1 1/4 x 1 1/4	1.660 x 1.660 x 1.660	0090-0712-082	3	6 13/32	5 17/32	1 5/16	3 1/4	
2 x 2 x 2	2.375 x 2.375 x 2.375	0090-0716-082	4	8 1/8	7 1/4	1 3/8	4 3/16	

# Style 90 Fittings for Water Service

For Joining Steel Pipe (Seal Only)

Nominal Size (IPS) (In.)	Outside Diameter (O.D.) (In.)	E-Coat Part Number	Overall Dimensions					Dimension Drawings
			A	B	C	D	E	
<b>90° ELL - SEAL ONLY</b>								
3/4	1.050	0090-0241-082	2 <sup>7</sup> / <sub>32</sub>	3 <sup>1</sup> / <sub>8</sub>	2	1 <sup>1</sup> / <sub>16</sub>	--	
1	1.315	0090-0242-082	2 <sup>9</sup> / <sub>16</sub>	3 <sup>3</sup> / <sub>16</sub>	2	3/4	--	
1 1/4	1.660	0090-0243-082	3	3 1/4	1 7/8	15/16	--	
1 1/2	1.900	0090-0244-082	3 3/8	3 19/32	2	1 1/8	--	
2	2.375	0090-0245-082	4	4 3/16	2 1/4	1 3/8	--	
<b>PLAIN END 90° STREET ELL - SEAL ONLY</b>								
3/4	1.050	0090-0270-082	2 <sup>7</sup> / <sub>32</sub>	3 <sup>9</sup> / <sub>16</sub>	3	2	9/16	
1	1.315	0090-0271-082	2 <sup>9</sup> / <sub>16</sub>	3 <sup>3</sup> / <sub>8</sub>	2 <sup>13</sup> / <sub>16</sub>	1 5/8	3/4	
1 1/4	1.660	0090-0272-082	3	4	3 <sup>3</sup> / <sub>16</sub>	1 7/8	7/8	
1 1/2	1.900	0090-0273-082	3 3/8	4 5/16	3 <sup>15</sup> / <sub>32</sub>	2	1	
2	2.375	0090-0274-082	4	5 1/8	4 1/16	2 1/4	1 1/4	
<b>THREADED END 90° ELL</b>								
1	1.315	0090-0331-082	2 <sup>9</sup> / <sub>16</sub>	2 <sup>5</sup> / <sub>16</sub>	2 <sup>13</sup> / <sub>16</sub>	1 5/8	3/4	
1 1/4	1.660	0090-0332-082	3	2 <sup>7</sup> / <sub>8</sub>	3 <sup>3</sup> / <sub>16</sub>	1 7/8	7/8	
2	2.375	0090-0334-082	4	3 1/2	4 1/16	2 1/4	1 1/4	
<b>STREET TEE - SEAL ONLY</b>								
1	1.315	0090-0391-082	2 <sup>9</sup> / <sub>16</sub>	1 5/8	2 3/4	2 <sup>13</sup> / <sub>16</sub>	1 5/8	
1 1/4	1.660	0090-0392-082	3	1 <sup>13</sup> / <sub>16</sub>	2 <sup>7</sup> / <sub>8</sub>	3 <sup>3</sup> / <sub>16</sub>	1 7/8	
1 1/2	1.900	0090-0393-082	3 3/8	2	3 1/16	3 <sup>15</sup> / <sub>32</sub>	2	
2	2.375	0090-0394-082	4	2 5/16	3 5/16	4 1/16	2 1/4	
<b>REDUCING STREET TEE - SEAL ONLY</b>								
1 1/4 x 1 1/4 x 1	1.660 x 1.660 x 1.315	0090-0451-082	2 <sup>9</sup> / <sub>16</sub>	1 3/4	2 3/4	2 <sup>15</sup> / <sub>16</sub>	1 5/8	
1 1/4 x 1 x 1 1/4	1.660 x 1.315 x 1.660	0090-0452-082	3	1 <sup>13</sup> / <sub>16</sub>	2 <sup>7</sup> / <sub>8</sub>	3 <sup>3</sup> / <sub>16</sub>	1 7/8	
1 1/2 x 1 1/2 x 1	1.900 x 1.900 x 1.315	0090-0453-082	2 <sup>9</sup> / <sub>16</sub>	2	2 <sup>3</sup> / <sub>4</sub>	3 <sup>1</sup> / <sub>16</sub>	1 5/8	
1 1/2 x 1 1/2 x 1 1/4	1.900 x 1.900 x 1.660	0090-0454-082	3	2	2 <sup>7</sup> / <sub>8</sub>	3 <sup>5</sup> / <sub>16</sub>	1 7/8	
1 1/2 x 1 1/4 x 1 1/2	1.900 x 1.660 x 1.900	0090-0456-082	3 3/8	2	3 1/8	3 <sup>15</sup> / <sub>32</sub>	2	
2 x 1 1/4 x 2	2.375 x 1.660 x 2.375	0090-0458-082	4	2 5/16	3 3/8	4 1/16	2 1/4	

# Style 90 Fittings for Water Service

For Joining Steel Pipe (Seal Only)

Nominal Size (IPS) (In.)	Outside Diameter (O.D.) (In.)	E-Coat Part Number	Overall Dimensions					Dimension Drawings
			A	B	C	D	E	
<b>MALE ADAPTER - SEAL ONLY</b>								
1 x 1 MIPS	1.315	0090-0741-082	2 <sup>9</sup> / <sub>16</sub>	4 <sup>1</sup> / <sub>4</sub>	3 <sup>13</sup> / <sub>16</sub>	--	--	
1 <sup>1</sup> / <sub>4</sub> x 1 <sup>1</sup> / <sub>4</sub> MIPS	1.660	0090-0757-082	3	4 <sup>7</sup> / <sub>16</sub>	3 <sup>7</sup> / <sub>8</sub>	--	--	
1 <sup>1</sup> / <sub>2</sub> x 1 <sup>1</sup> / <sub>2</sub> MIPS	1.900	0090-0743-082	3 <sup>3</sup> / <sub>8</sub>	4 <sup>9</sup> / <sub>16</sub>	3 <sup>7</sup> / <sub>8</sub>	--	--	
2 x 2 MIPS	2.375	0090-0744-082	4	4 <sup>11</sup> / <sub>16</sub>	4	--	--	
<b>LINE CAP - SEAL ONLY</b>								
3/4	1.050	0090-0860-082	2 <sup>7</sup> / <sub>32</sub>	3 <sup>1</sup> / <sub>8</sub>	2 <sup>11</sup> / <sub>16</sub>	--	--	
1	1.315	0090-0861-082	2 <sup>9</sup> / <sub>16</sub>	3 <sup>1</sup> / <sub>8</sub>	2 <sup>11</sup> / <sub>16</sub>	--	--	
1 <sup>1</sup> / <sub>4</sub>	1.660	0090-0862-082	3	3 <sup>1</sup> / <sub>8</sub>	2 <sup>11</sup> / <sub>16</sub>	--	--	
1 <sup>1</sup> / <sub>2</sub>	1.900	0090-0863-082	3 <sup>3</sup> / <sub>8</sub>	3 <sup>5</sup> / <sub>32</sub>	2 <sup>11</sup> / <sub>16</sub>	--	--	
2	2.375	0090-0864-082	4	3 <sup>1</sup> / <sub>4</sub>	2 <sup>11</sup> / <sub>16</sub>	--	--	

# Style 90 Insulating Fittings for Water Service

Insulating Fittings for Joining Steel Pipe (Seal Only)

Nominal Size (IPS) (In.)	Outside Diameter (O.D.) (In.)	E-Coat Part Number	Overall Dimensions					Dimension Drawings
			A	B	C	D	E	
<b>CAST INSULATING COUPLING WITH 5" MIDDLE RING - SEAL ONLY</b>								
3/4	1.050	0090-1677-192	2 <sup>7</sup> / <sub>32</sub>	6 <sup>3</sup> / <sub>8</sub>	5	--	--	
1	1.315	0090-1678-192	2 <sup>9</sup> / <sub>16</sub>	6 <sup>3</sup> / <sub>8</sub>	5	--	--	
1 <sup>1</sup> / <sub>4</sub>	1.660	0090-1679-192	3	6 <sup>3</sup> / <sub>8</sub>	5	--	--	
1 <sup>1</sup> / <sub>2</sub>	1.900	0090-1680-192	3 <sup>3</sup> / <sub>8</sub>	5 <sup>13</sup> / <sub>16</sub>	5	--	--	
2	2.375	0090-1681-192	4	6 <sup>5</sup> / <sub>8</sub>	5	--	--	
<b>STEEL INSULATING COUPLING WITH 5" MIDDLE RING - SEAL ONLY</b>								
3/4	1.050	0090-2127-192	2 <sup>7</sup> / <sub>32</sub>	6 <sup>3</sup> / <sub>8</sub>	5	--	--	
1	1.315	0090-2128-192	2 <sup>9</sup> / <sub>16</sub>	6 <sup>3</sup> / <sub>8</sub>	5	--	--	
1 <sup>1</sup> / <sub>4</sub>	1.660	0090-2129-192	3	6 <sup>3</sup> / <sub>8</sub>	5	--	--	
1 <sup>1</sup> / <sub>2</sub>	1.900	0090-2130-192	3 <sup>3</sup> / <sub>8</sub>	5 <sup>13</sup> / <sub>16</sub>	5	--	--	
2	2.375	0090-2131-192	4	6 <sup>5</sup> / <sub>8</sub>	5	--	--	

# Style 90 Fittings for Water Service

## Insulating Fittings for Joining Steel Pipe (Seal Only)

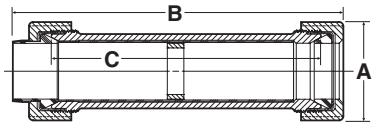
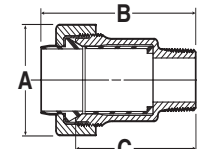
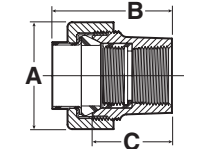
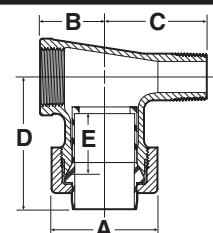
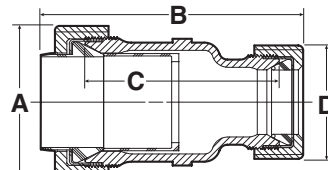
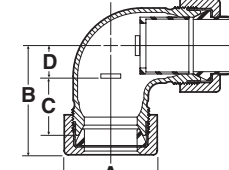
Nominal Size (IPS) (In.)	Outside Diameter (O.D.) (In.)	E-Coat Part Number	Overall Dimensions					Dimension Drawings
			A	B	C	D	E	
<b>STEEL INSULATING COUPLING WITH 10" MIDDLE RING - SEAL ONLY</b>								
3/4	1.050	0090-0120-091	27/32	113/8	10	--	--	
1	1.315	0090-0121-091	29/16	113/8	10	--	--	
1 1/4	1.660	0090-0122-091	3	113/8	10	--	--	
1 1/2	1.900	0090-0123-091	33/8	113/8	10	--	--	
2	2.375	0090-0124-091	4	115/8	10	--	--	
<b>MALE INSULOK ADAPTER - SEAL ONLY</b>								
3/4	1.050	0090-0800-039	27/32	37/16	23/4	--	--	
1	1.315	0090-0801-039	29/16	35/16	25/8	--	--	
1 1/4	1.660	0090-0802-039	3	39/16	27/8	--	--	
<b>FEMALE INSULOK ADAPTER - SEAL ONLY</b>								
3/4	1.050	0090-0833-039	27/32	29/16	17/8	--	--	
1	1.315	0090-0831-039	29/16	213/16	21/8	--	--	
1 1/4	1.660	0090-0835-039	3	215/16	21/4	--	--	
<b>INSULATING REDUCING STREET TEE - SEAL ONLY</b>								
1 1/4 x 1 1/4 x 1	1.660 x 1.660 x 1.315	0090-0500-033	29/16	13/4	23/4	37/16	15/8	
1 1/4 x 1 x 1 1/4	1.660 x 1.315 x 1.660	0090-0501-033	3	113/16	27/8	311/16	17/8	
1 1/2 x 1 1/4 x 1 1/2	1.900 x 1.660 x 1.900	0090-0503-033	33/8	2	31/8	4	2	
1 1/2 x 1 1/2 x 1 1/4	1.900 x 1.900 x 1.660	0090-0506-033	3	2	27/8	311/16	17/8	
2 x 1 1/4 x 2	2.375 x 1.660 x 2.375	0090-0504-033	4	25/16	33/8	49/16	21/4	
2 x 1 1/2 x 2	2.375 x 1.900 x 2.375	0090-0505-033	4	25/16	35/16	49/16	21/4	
<b>INSULATING REDUCING COUPLING - LARGER END INSULATED - SEAL ONLY</b>								
1 x 3/4	1.315 x 1.050	0090-0630-084	29/16	63/8	5	27/32	--	
1 1/4 x 3/4	1.660 x 1.050	0090-0631-084	3	63/8	5	27/32	--	
1 1/4 x 1	1.660 x 1.315	0090-0632-084	3	63/8	5	29/16	--	
1 1/2 x 1	1.900 x 1.315	0090-0633-084	33/8	63/8	5	29/16	--	
1 1/2 x 1 1/4	1.900 x 1.660	0090-0634-084	33/8	63/8	5	3	--	
2 x 1 1/4	2.375 x 1.660	0090-0637-084	4	61/2	5	3	--	
2 x 1 1/2	2.375 x 1.900	0090-0636-084	4	61/2	5	33/8	--	
<b>INSULATING 90° ELL - SEAL ONLY</b>								
3/4	1.050	0090-1451-084	27/32	35/8	2	11/16	--	
1	1.315	0090-1452-084	29/16	311/16	2	3/4	--	
1 1/4	1.660	0090-1453-084	3	33/4	17/8	15/16	--	
1 1/2	1.900	0090-1454-084	33/8	41/8	2	11/8	--	
2	2.375	0090-1455-084	4	411/16	21/4	13/8	--	

# Style 90 Fittings for Water Service

## Insulating Fittings for Joining Steel Pipe (Seal Only)

Nominal Size (IPS) (In.)	Outside Diameter (O.D.) (In.)	E-Coat Part Number	Overall Dimensions					Dimension Drawings
			A	B	C	D	E	
<b>INSULATING 90° PLAIN END STREET ELL - SEAL ONLY</b>								
1	1.315	0090-0301-033	2 <sup>9/16</sup>	3 <sup>3/8</sup>	3 <sup>5/16</sup>	1 <sup>5/8</sup>	3/4	
1 <sup>1/4</sup>	1.660	0090-0302-033	3	4	3 <sup>11/16</sup>	1 <sup>7/8</sup>	7/8	
1 <sup>1/2</sup>	1.900	0090-0303-033	3 <sup>3/8</sup>	4 <sup>5/16</sup>	4	2	1	
2	2.375	0090-0304-033	4	5 <sup>1/8</sup>	4 <sup>9/16</sup>	2 <sup>1/4</sup>	1 <sup>1/4</sup>	
<b>INSULATING STREET TEE - SEAL ONLY</b>								
1	1.315	0090-0421-033	2 <sup>9/16</sup>	1 <sup>5/8</sup>	2 <sup>3/4</sup>	3 <sup>5/16</sup>	1 <sup>5/8</sup>	
1 <sup>1/4</sup>	1.660	0090-0422-033	3	1 <sup>13/16</sup>	2 <sup>7/8</sup>	3 <sup>11/16</sup>	1 <sup>7/8</sup>	
1 <sup>1/2</sup>	1.900	0090-0423-033	3 <sup>3/8</sup>	2	3 <sup>1/16</sup>	4	2	
2	2.375	0090-0424-033	4	2 <sup>5/16</sup>	3 <sup>5/16</sup>	4 <sup>9/16</sup>	2 <sup>1/4</sup>	
<b>INSULATING 90° THREADED END STREET ELL - SEAL ONLY</b>								
1	1.315	0090-0361-033	2 <sup>9/16</sup>	2 <sup>5/16</sup>	3 <sup>5/16</sup>	1 <sup>5/8</sup>	3/4	
1 <sup>1/4</sup>	1.660	0090-0362-033	3	2 <sup>7/8</sup>	3 <sup>11/16</sup>	1 <sup>7/8</sup>	7/8	
1 <sup>1/2</sup>	1.900	0090-0364-033	3 <sup>3/8</sup>	2 <sup>7/8</sup>	4	2	1	
2	2.375	0090-0365-033	4	3 <sup>1/2</sup>	4 <sup>9/16</sup>	2 <sup>1/4</sup>	1 <sup>1/4</sup>	

**NOTE: STYLE 90 PRODUCTS** SHOWN IN THIS CATALOG ARE FOR USE ON STEEL PIPE, SEAL ONLY. FOR ALL IPS, PLASTIC PIPE AND RESTRAINING COUPLINGS, PLEASE REFER TO THE DRESSER UNIVERSAL STYLE 90 PRODUCT LINE.